

Reinson



## EU028

Uniwersalny uchylny uchwyt ścienny do telewizorów i monitorów LCD, LED, TFT, OLED i plazmowych o przekątnej 37-70".

Universal tilt wall bracket for LCD, LED, TFT, OLED and plasma TV and monitor with screen size range 37-70".



Drogi Kliencie,  
dziękujemy za wybór Produktu Reinston, mamy nadzieję,  
że jego użytkowanie przyniesie wiele zadowolenia.  
Prosimy o zapoznanie się z poniższymi informacjami zamieszczonymi  
w instrukcji obsługi oraz gwarancji.

Dear Client,  
thank you for choosing the Reinston Product.  
We hope that it will be of great use for you. Please, read the terms and  
conditions included in below manual and warranty.

#### UWAGA!

Monitor plazmowy, LED, OLED, LCD, telewizor, projektor, ekran projekcyjny lub inny sprzęt HiFi stanowi znaczną wartość. Jeśli dołączono do niego śruby mocujące, mogą one nie być odpowiednie do materiału, z którego wykonane są dane ściany, sufit lub podłoga. Może istnieć potrzeba aby je zastąpić odpowiednimi śrubami. W razie jakichkolwiek wątpliwości dotyczących montowania tego urządzenia należy zasięgnąć porady u specjalisty.

#### IMPORTANT!

Your Plasma, LED, OLED, LCD, TV, Projector, Projection Screen or other HiFi equipment represents a considerable value. If screws are included they may not be suitable for the material of your wall, ceiling or floor. Replace the screws with suitable ones if needed. In case you are unsure regarding any aspects of the mounting of this product please consult a professional.











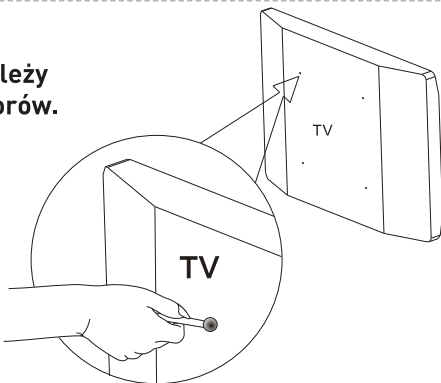





### OSTRZEŻENIE!

Przed przystąpieniem do montażu należy koniecznie sprawdzić głębokość otworów.

### WARNING!

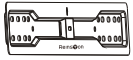
Always check the depth of the holes before starting an installation.



 A (x2)	 M5x14 (x4) M-A	 M6x14 (x4) M-B	 M6x30 (x4) M-C	 M8x30 (x4) M-D	 M8x50 (x4) M-E	 D5 (x4) M-F	 D8 (x4) M-G	 (x8) M-H	 (x8) M-I
 B (x1)	 C (x1)		 W-A (x4)	 W-B (x4)	 W-C (x4)				

### 1a

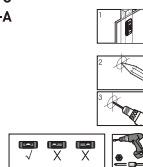
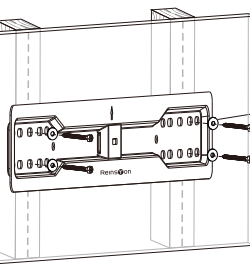
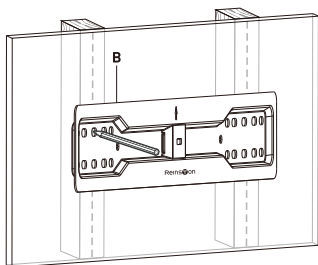
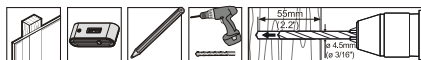

### 1b

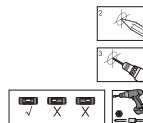
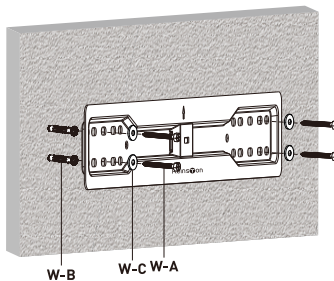
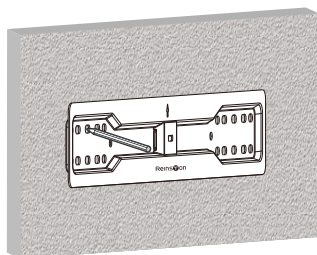
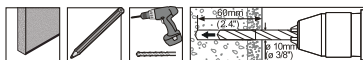

2a

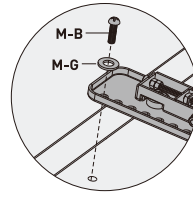
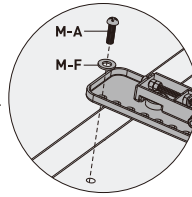
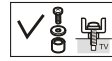
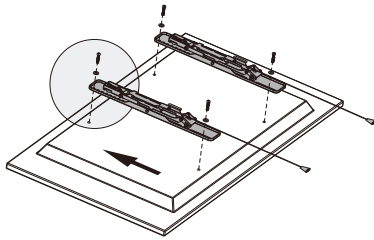

2b

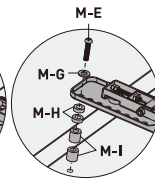
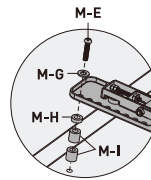
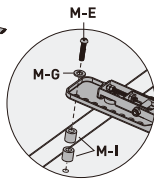
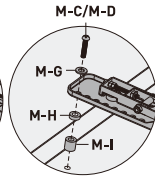
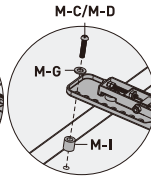
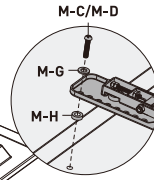
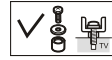
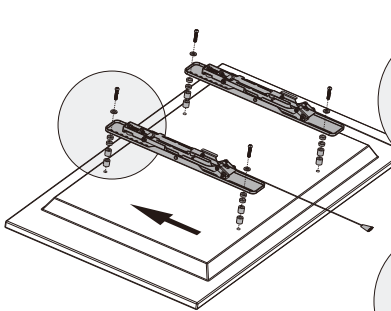

3

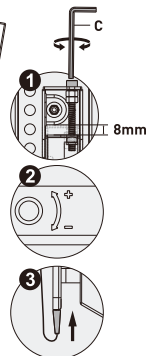
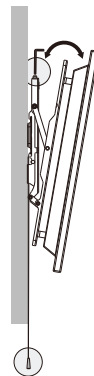

4

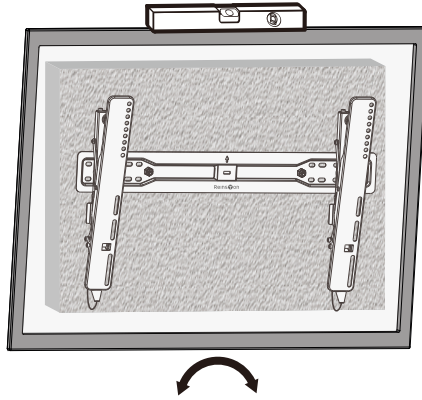

5

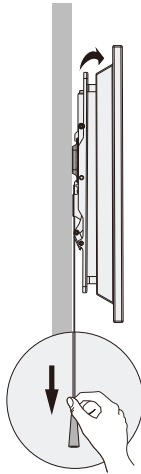



## **Gwarancja**

1. Gwarant - Multibrackets Europe AB z siedzibą w Sztokholmie, Szwecja, adres: Sztokholm (111- 40), Szwecja, Döbelngatan 21, udziela nabywcy 60 miesięcznej gwarancji na wolne od wad funkcjonowanie uchwytu ściennego do TV (Produkt) licząc od daty nabycia Produktu przez nabywcę. Paragon lub faktura, wystawione przez sprzedawcę Produktu, potwierdzają datę jego nabycia.
2. Gwarant w okresie gwarancji wymieni na swój koszt wadliwy Produkt na Produkt wolny od wad. Gwarant zobowiązuje się wymienić wadliwy Produkt, na wolny od wad, w terminie nie dłuższym niż 21 dni roboczych od zgłoszenia przez nabywcę wadliwości Produktu.
3. W celu skorzystania z gwarancji nabywca zobowiązany jest zgłosić wadliwość Produktu w punkcie sprzedawcy, w którym Produkt został nabyty oraz dostarczyć tam wadliwy Produkt. Produkt wolny od wad zostanie, na koszt Gwaranta, dostarczony do punktu sprzedawcy, w którym Produkt został nabyty.
4. Gwarancja obejmuje obszar Rzeczypospolitej Polskiej. Przedstawicielem Gwaranta w Rzeczypospolitej Polskiej jest MB Polska Sp. z o.o. z siedzibą w Gdańsku, adres: 80-382 Gdańsk, ul. Beniowskiego 5.
5. Gwarancja nie obejmuje wad Produktu spowodowanych przez nabywcę oraz wynikających z używania lub montażu Produktu niezgodnych z instrukcją Produktu.
6. Postanowienia gwarancji nie wyłączają, ani nie ograniczają, ani nie zawieszają uprawnień nabywców (konsumentów) wynikających z niezgodności towaru z umową.

## **Warranty**

1. Guarantor – Multibrackets Europe Ab with headquarters located in Stockholm, Sweden, address: Stockholm [ 111-40], Sweden, Döbelngatan 21, grants the buyer a 60 month warranty on fault-free functioning of the wall mount for the TV (Product) counting from the date of purchase. The receipt or invoice issued by the seller of the Product confirms the date of purchase.
2. The Guarantor will, at the time of the warranty, replace the defective Product for defect-free Product at its own expense. The Guarantor undertakes to replace the defective Product, free of defects, within no more than 21 days working days from the date the purchaser claimed the Product.
3. In order to use the warranty, the purchaser is obliged to claim the defect of the Product in the point of purchase and deliver defective Product there. Product free from the defects will be, at the expense of the Guarantor, delivered to the point where the Product was purchased.
4. The warranty covers the territory of the Republic of Poland. Representative of the Guarantor in Poland is MB Polska Sp. z o.o. based in Gdańsk, adres: 80-382 Gdańsk, ul. Beniowskiego 5.
5. The warranty does not cover Product defects caused by the purchaser resulting from not proper use or assemble of the Product incompatible with the instructions manuals included into Product box.
6. The terms of the guarantee do not exclude or limit or suspend the rights buyers (consumers) resulting from incompatibility of the goods with the contract.