

DENON

FULLY AUTOMATIC TURNTABLE SYSTEM

DP-200USB

Owner's Manual

Bedienungsanleitung

Manuel de l'Utilisateur

Manuale delle istruzioni

Manual del usuario

Gebruiksaanwijzing

Bruksanvisning

☐ SAFETY PRECAUTIONS



CAUTION
RISK OF ELECTRIC SHOCK
DO NOT OPEN



CAUTION:
TO REDUCE THE RISK OF ELECTRIC SHOCK, DO NOT REMOVE COVER (OR BACK). NO USER-SERVICEABLE PARTS INSIDE. REFER SERVICING TO QUALIFIED SERVICE PERSONNEL.

The lightning flash with arrowhead symbol, within an equilateral triangle, is intended to alert the user to the presence of uninsulated "dangerous voltage" within the product's enclosure that may be of sufficient magnitude to constitute a risk of electric shock to persons.

The exclamation point within an equilateral triangle is intended to alert the user to the presence of important operating and maintenance (servicing) instructions in the literature accompanying the appliance.

WARNING:
TO REDUCE THE RISK OF FIRE OR ELECTRIC SHOCK, DO NOT EXPOSE THIS APPLIANCE TO RAIN OR MOISTURE.

• Location of Caution Labels: Bottom

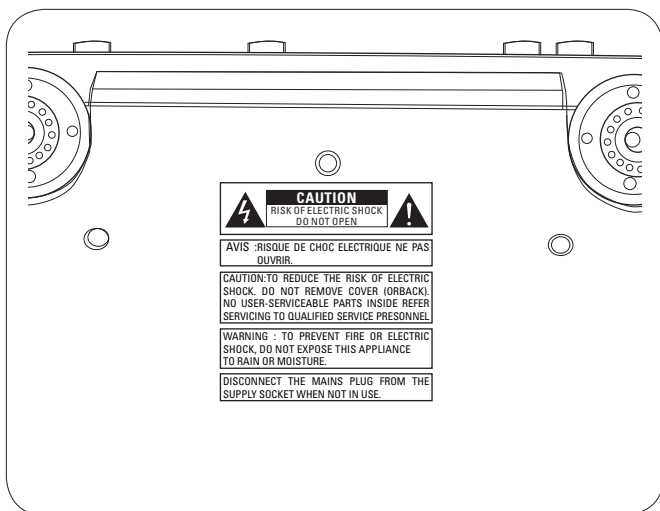

- **DECLARATION OF CONFORMITY**
We declare under our sole responsibility that this product, to which this declaration relates, is in conformity with the following standards: EN60065, EN55013, EN55020, EN61000-3-2 and EN61000-3-3. Following the provisions of 2006/95/EC and 2004/108/EC Directive.
- **ÜBEREINSTIMMUNGSERKLÄRUNG**
Wir erklären unter unserer Verantwortung, daß dieses Produkt, auf das sich diese Erklärung bezieht, den folgenden Standards entspricht: EN60065, EN55013, EN55020, EN61000-3-2 und EN61000-3-3. Entspricht den Verordnungen der Direktive 2006/95/EC und 2004/108/EC.
- **DECLARATION DE CONFORMITE**
Nous déclarons sous notre seule responsabilité que l'appareil, auquel se réfère cette déclaration, est conforme aux standards suivants: EN60065, EN55013, EN55020, EN61000-3-2 et EN61000-3-3. D'après les dispositions de la Directive 2006/95/EC et 2004/108/EC.
- **DICHIARAZIONE DI CONFORMITÀ**
Dichiariamo con piena responsabilità che questo prodotto, al quale la nostra dichiarazione si riferisce, è conforme alle seguenti normative: EN60065, EN55013, EN55020, EN61000-3-2 e EN61000-3-3. In conformità con le condizioni delle direttive 2006/95/EC e 2004/108/EC. QUESTO PRODOTTO E' CONFORME AL D.M. 28/08/95 N. 548
- **DECLARACIÓN DE CONFORMIDAD**
Declaramos bajo nuestra exclusiva responsabilidad que este producto al que hace referencia esta declaración, está conforme con los siguientes estándares: EN60065, EN55013, EN55020, EN61000-3-2 y EN61000-3-3. Siguiendo las provisiones de las Directivas 2006/95/EC y 2004/108/EC.
- **EENVORMIGHEIDSVERKLARING**
Wij verklaren uitsluitend op onze verantwoordelijkheid dat dit product, waarop deze verklaring betrekking heeft, in overeenstemming is met de volgende normen: EN60065, EN55013, EN55020, EN61000-3-2 en EN61000-3-3. Volgens de bepalingen van de Richtlijnen 2006/95/EC en 2004/108/EC.
- **ÖVERENSSTÄMMELSESINTYG**
Härmed intygas helt på eget ansvar att denna produkt, vilken detta intyg avser, uppfyller följande standarder: EN60065, EN55013, EN55020, EN61000-3-2 och EN61000-3-3. Enligt stadgarna i direktiv 2006/95/EC och 2004/108/EC.

DENON EUROPE
Division of D&M Germany GmbH
An der Landwehr 19, Nettetal,
D-41334 Germany

CAUTION:
To completely disconnect this product from the mains, disconnect the plug from the wall socket outlet.
The mains plug is used to completely interrupt the power supply to the unit and must be within easy access by the user.

VORSICHT:
Um dieses Gerät vollständig von der Stromversorgung abzutrennen, ziehen Sie bitte den Stecker aus der Wandsteckdose.
Der Netzstecker wird verwendet, um die Stromversorgung zum Gerät völlig zu unterbrechen; er muss für den Benutzer gut und einfach zu erreichen sein.

PRECAUTION:
Pour déconnecter complètement ce produit du courant secteur, débranchez la prise de la prise murale.
La prise secteur est utilisée pour couper complètement l'alimentation de l'appareil et l'utilisateur doit pouvoir y accéder facilement.







ATTENZIONE:
Per scollegare completamente questo prodotto dalla rete di alimentazione elettrica, scollegare la spina dalla relativa presa a muro.
La spina di rete viene utilizzata per interrompere completamente l'alimentazione all'unità e deve essere facilmente accessibile all'utente.

PRECAUCIÓN:
Para desconectar completamente este producto de la alimentación eléctrica, desconecte el enchufe del enchufe de la pared.
El enchufe de la alimentación eléctrica se utiliza para interrumpir por completo el suministro de alimentación eléctrica a la unidad y debe de encontrarse en un lugar al que el usuario tenga fácil acceso.

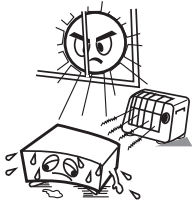
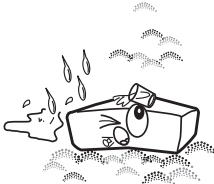
WAARSCHUWING:
Om de voeding van dit product volledig te onderbreken moet de stekker uit het stopcontact worden getrokken.
De netstekker wordt gebruikt om de stroomtoevoer naar het toestel volledig te onderbreken en moet voor de gebruiker gemakkelijk bereikbaar zijn.

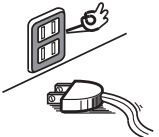
FÖRSIKTIHETSMÅTT:
Koppla loss stickproppen från eluttaget för att helt skilja produkten från nätet.
Stickproppen används för att helt bryta strömförsörjningen till apparaten, och den måste vara lättillgänglig för användaren.

NOTE ON USE / HINWEISE ZUM GEBRAUCH / OBSERVATIONS RELATIVES A L'UTILISATION / NOTE SULL'USO / NOTAS SOBRE EL USO / ALVORENSTE GEBRUIKEN / OBSERVERA ANGÅENDE ANVÄNDNINGEN

 <ul style="list-style-type: none"> • Avoid high temperatures. Allow for sufficient heat dispersion when installed in a rack. • Vermeiden Sie hohe Temperaturen. Beachten Sie, dass eine ausreichende Belüftung gewährleistet wird, wenn das Gerät auf ein Regal gestellt wird. • Eviter des températures élevées. Tenir compte d'une dispersion de chaleur suffisante lors de l'installation sur une étagère. • Evitate di esporre l'unità a temperature elevate. Assicuratevi che vi sia un'adeguata dispersione del calore quando installate l'unità in un mobile per componenti audio. • Evite altas temperaturas. Permite la suficiente dispersión del calor cuando está instalado en la consola. • Vermijd hoge temperaturen. Zorg er bij installatie in een audiorack voor, dat de door het toestel geproduceerde warmte goed kan worden afgevoerd. • Undvik höga temperaturer. Se till att det finns möjlighet till god värmeavledning vid montering i ett rack. 	 <ul style="list-style-type: none"> • Keep the unit free from moisture, water, and dust. • Halten Sie das Gerät von Feuchtigkeit, Wasser und Staub fern. • Protéger l'appareil contre l'humidité, l'eau et la poussière. • Tenete l'unità lontana dall'umidità, dall'acqua e dalla polvere. • Mantenga el equipo libre de humedad, agua y polvo. • Laat geen vochtigheid, water of stof in het apparaat binnendringen. • Utsätt inte apparaten för fukt, vatten och damm. 	 <ul style="list-style-type: none"> • Do not let foreign objects into the unit. • Lassen Sie keine fremden Gegenstände in das Gerät kommen. • Ne pas laisser des objets étrangers dans l'appareil. • Non inserite corpi estranei all'interno dell'unità. • No deje objetos extraños dentro del equipo. • Laat geen vreemde voorwerpen in dit apparaat vallen. • Se till att främmande föremål inte tränger in i apparaten. 	<p>CAUTION:</p> <ul style="list-style-type: none"> • The ventilation should not be impeded by covering the ventilation openings with items, such as newspapers, tablecloths, curtains, etc. • No naked flame sources, such as lighted candles, should be placed on the unit. • Do not expose the unit to dripping or splashing fluids. • Do not place objects filled with liquids, such as vases, on the unit. <p>ACHTUNG:</p> <ul style="list-style-type: none"> • Die Belüftung sollte auf keinen Fall durch das Abdecken der Belüftungsöffnungen durch Gegenstände wie beispielsweise Zeitungen, Tischtücher, Vorhänge o. Ä. behindert werden. • Auf dem Gerät sollten keinerlei direkte Feuerquellen wie beispielsweise angezündete Kerzen aufgestellt werden. • Das Gerät sollte keiner tropfenden oder spritzenden Flüssigkeit ausgesetzt werden. • Auf dem Gerät sollten keine mit Flüssigkeit gefüllten Behälter wie beispielsweise Vasen aufgestellt werden.
 <ul style="list-style-type: none"> • Handle the power cord carefully. Hold the plug when unplugging the cord. • Gehen Sie vorsichtig mit dem Netzkabel um. Halten Sie das Kabel am Stecker, wenn Sie den Stecker herausziehen. • Manipuler le cordon d'alimentation avec précaution. Tenir la prise lors du débranchement du cordon. • Maneggiare il cavo di alimentazione con attenzione. Tenete ferma la spina quando scollegate il cavo dalla presa. • Maneje el cordón de energía con cuidado. Sostenga el enchufe cuando desconecte el cordón de energía. • Hanteer het netsnoer voorzichtig. Houd het snoer bij de stekker vast wanneer deze moet worden aan- of losgekoppeld. • Hantera nätkabeln varsamt. Håll i kabeln när den kopplas från el-uttaget. 	 <ul style="list-style-type: none"> • Unplug the power cord when not using the unit for long periods of time. • Wenn das Gerät längere Zeit nicht verwendet werden soll, trennen Sie das Netzkabel vom Netzstecker. • Débrancher le cordon d'alimentation lorsque l'appareil n'est pas utilisé pendant de longues périodes. • Scollegate il cavo di alimentazione quando prevedete di non utilizzare l'unità per un lungo periodo di tempo. • Desconecte el cordón de energía cuando no utilice el equipo por mucho tiempo. • Neem altijd het netsnoer uit het stopkontakt wanneer het apparaat gedurende een lange periode niet wordt gebruikt. • Koppla loss nätkabeln om apparaten inte kommer att användas i lång tid. 	 <ul style="list-style-type: none"> • Do not let insecticides, benzene, and thinner come in contact with the unit. • Lassen Sie das Gerät nicht mit Insektiziden, Benzin oder Verdünnungsmitteln in Berührung kommen. • Ne pas mettre en contact des insecticides, du benzène et un diluant avec l'appareil. • Assicuratevi che l'unità non entri in contatto con insetticidi, benzolo o solventi. • No permita el contacto de insecticidas, gasolina y diluyentes con el equipo. • Voorkom dat insecticiden, benzeen of verfverdunder met dit toestel in contact komen. • Se till att inte insektsmedel på spraybruk, bensen och thinner kommer i kontakt med apparatens hölje. 	<p>ATTENTION:</p> <ul style="list-style-type: none"> • La ventilation ne doit pas être gênée en recouvrant les ouvertures de la ventilation avec des objets tels que journaux, rideaux, tissus, etc. • Aucune flamme nue, par exemple une bougie, ne doit être placée sur l'appareil. • L'appareil ne doit pas être exposé à l'eau ou à l'humidité. • Ne pas poser d'objet contenant du liquide, par exemple un vase, sur l'appareil. <p>ATTENZIONE:</p> <ul style="list-style-type: none"> • Le aperture di ventilazione non devono essere ostruite coprendole con oggetti, quali giornali, tovaglie, tende e così via. • Non posizionate sull'unità fiamme libere, come ad esempio candele accese. • L'apparecchiatura non deve essere esposta a gocciolii o spruzzi. • Non posizionate sull'unità alcun oggetto contenente liquidi, come ad esempio i vasi. <p>PRECAUCIÓN:</p> <ul style="list-style-type: none"> • La ventilación no debe quedar obstruida por haberse cubierto las aperturas con objetos como periódicos, manteles, cortinas, etc. • No debe colocarse sobre el aparato ninguna fuente inflamable sin protección, como velas encendidas. • No exponer el aparato al goteo o salpicaduras cuando se utilice. • No colocar sobre el aparato objetos llenos de líquido, como jarros. <p>WAARSCHUWING:</p> <ul style="list-style-type: none"> • De ventilatie mag niet worden belemmerd door de ventilatieopeningen af te dekken met bijvoorbeeld kranten, een tafelkleed, gordijnen, enz. • Plaats geen open vlammen, bijvoorbeeld een brandende kaars, op het apparaat. • Stel het apparaat niet bloot aan druppels of spatten. • Plaats geen voorwerpen gevuld met water, bijvoorbeeld een vaas, op het apparaat.
	 <p>* (For apparatuses with ventilation holes)</p> <ul style="list-style-type: none"> • Do not obstruct the ventilation holes. • Decken Sie den Lüftungsbereich nicht ab. • Ne pas obstruer les trous d'aération. • Non coprite i fori di ventilazione. • No obstruya los orificios de ventilación. • De ventilatieopeningen mogen niet worden geblokkeerd. • Täpp inte till ventilationsöppningarna. 	 <ul style="list-style-type: none"> • Never disassemble or modify the unit in any way. • Versuchen Sie niemals das Gerät auseinander zu nehmen oder zu verändern. • Ne jamais démonter ou modifier l'appareil d'une manière ou d'une autre. • Non smontate né modificate l'unità in alcun modo. • Nunca desarme o modifique el equipo de ninguna manera. • Dit toestel mag niet gedemonteerd of aangepast worden. • Ta inte isär apparaten och försök inte bygga om den. 	<p>OBSERVERA:</p> <ul style="list-style-type: none"> • Ventilationen bör inte förhindras genom att täcka för ventilationsöppningarna med föremål såsom tidningar, bordsdukar, gardiner osv. • Inga blottade brandkällor, såsom tända ljus, får placeras på apparaten. • Apparaten får inte utsättas för vätska. • Placera inte föremål fyllda med vätska, t.ex. vaser, på apparaten.

A NOTE ABOUT RECYCLING:

This product's packaging materials are recyclable and can be reused. Please dispose of any materials in accordance with the local recycling regulations.

When discarding the unit, comply with local rules or regulations.

Batteries should never be thrown away or incinerated but disposed of in accordance with the local regulations concerning battery disposal.

This product and the supplied accessories, excluding the batteries, constitute the applicable product according to the WEEE directive.

HINWEIS ZUM RECYCLING:

Das Verpackungsmaterial dieses Produktes ist zum Recyceln geeignet und kann wieder verwendet werden. Bitte entsorgen Sie alle Materialien entsprechend der örtlichen Recycling-Vorschriften.

Beachten Sie bei der Entsorgung des Gerätes die örtlichen Vorschriften und Bestimmungen.

Die Batterien dürfen nicht in den Hausmüll geworfen oder verbrannt werden; bitte entsorgen Sie die Batterien gemäß der örtlichen Vorschriften.

Dieses Produkt und das im Lieferumfang enthaltene Zubehör (mit Ausnahme der Batterien!) entsprechen der WEEE-Direktive.

UNE REMARQUE CONCERNANT LE RECYCLAGE:

Les matériaux d'emballage de ce produit sont recyclables et peuvent être réutilisés. Veuillez disposer des matériaux conformément aux lois sur le recyclage en vigueur.

Lorsque vous mettez cet appareil au rebut, respectez les lois ou réglementations en vigueur.

Les piles ne doivent jamais être jetées ou incinérées, mais mises au rebut conformément aux lois en vigueur sur la mise au rebut des piles.

Ce produit et les accessoires inclus, à l'exception des piles, sont des produits conformes à la directive DEEE.

NOTA RELATIVA AL RICICLAGGIO:

I materiali di imballaggio di questo prodotto sono riutilizzabili e riciclabili. Smaltire i materiali conformemente alle normative locali sul riciclaggio.

Per lo smaltimento dell'unità, osservare le normative o le leggi locali in vigore.

Non gettare le batterie, né incenerirle, ma smaltirle conformemente alla normativa locale sui rifiuti chimici.

Questo prodotto e gli accessori inclusi nell'imballaggio sono applicabili alla direttiva RAEE, ad eccezione delle batterie.

ACERCA DEL RECICLAJE:

Los materiales de embalaje de este producto son reciclables y se pueden volver a utilizar. Disponga de estos materiales siguiendo los reglamentos de reciclaje de su localidad.

Cuando se deshaga de la unidad, cumpla con las reglas o reglamentos locales.

Las pilas nunca deberán tirarse ni incinerarse. Deberá disponer de ellas siguiendo los reglamentos de su localidad relacionados con los desperdicios químicos.

Este producto junto con los accesorios empaquetados es el producto aplicable a la directiva RAEE excepto pilas.

EEN AANTEKENING MET BETREKKING TOT DE RECYCLING:

Het inpakmateriaal van dit product is recycleerbaar en kan opnieuw gebruikt worden. Er wordt verzocht om zich van elk afvalmateriaal te ontdoen volgens de plaatselijke voorschriften.

Volg voor het wegdoen van de speler de voorschriften voor de verwijdering van wit- en bruingoed op.

Batterijen mogen nooit worden weggegooid of verbrand, maar moeten volgens de plaatselijke voorschriften betreffende chemisch afval worden verwijderd.

Op dit product en de meegeleverde accessoires, m.u.v. de batterijen is de richtlijn voor afgedankte elektrische en elektronische apparaten (WEEE) van toepassing.

OBSERVERA ANGÅENDE ÅTERTVINNING:

Produktens emballage är återvinningsbart och kan återanvändas. Kassera det enligt lokala återvinningsbestämmelser.

När du kasserar enheten ska du göra det i överensstämmelse med lokala regler och bestämmelser.

Batterier får absolut inte kastas i soporna eller brännas. Kassera dem enligt lokala bestämmelser för kemiskt avfall.

Denna apparat och de tillbehör som levereras med den uppfyller gällande WEEE-direktiv, med undantag av batterierna.



Pb

□ Contents

Getting Started	
Accessories	1
Special Features of This Device	1
Cautions on Handlings	1
Cleaning	1
Assembly	2
Changing the Stylus	2
Removing the Replaceable Stylus	2
Mounting the Replaceable Stylus	2
Part Names and Functions	3
Connections	
Connections	4
Connecting the Power Cord	4
Playback	
Preparations	5
Preparing to Play a Record	5
Playing an Analog Record	5
Auto Start	5
Manual Start	5
Stopping a Record During Playback	5
Recording and Editing	
Recording an Analog Record and Editing the Recording	6
Cautions to Observe When Recording or Editing	7
Recording	8
Recording to a USB Flash Drive	8
Editing	8
Shall be Enabled by Trans Music Manager for DENON	8
Recommended System Requirements for Using Trans Music Manager	8
Installing "Trans Music Manager"	8
Editing with Trans Music Manager	8
Troubleshooting	
9	
Specifications	
10	

Getting Started

Thank you for purchasing this DENON product. To ensure proper operation, please read this owner's manual carefully before using the product.
After reading them, be sure to keep them for future reference.

Accessories

Check that the following parts are supplied with the product.

- ① Owner's manual 1
- ② Service station list 1
- ③ Platter 1
- ④ Rubber mat 1
- ⑤ EP adapter 1
- ⑥ Trans Music Manager (for DENON) disk (CD-ROM)..... 1

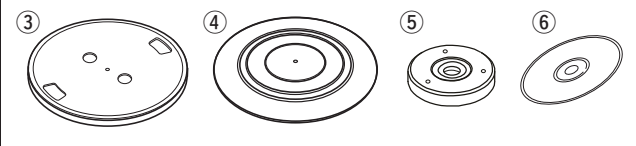

Note that the illustrations in this instructions may differ from the actual set for explanation purposes.

Special Features of This Device

- 1. Record analog records to a USB flash drive**
 - You can play back the tracks recorded on the USB flash drive on any audio device with USB playback.
 - The "Trans Music Manager" software supplied with the DP-200USB enables you to edit music files and titles on your PC.
- 2. Easy-to-operate, fully automatic player**

Simply press **START** button to start playing an analog record. When the record is finished the tone arm automatically returns to its original position and the turntable stops.
- 3. Equalizer switch provided**

The equalizer switch enables you to connect to a variety of audio devices such as pre-main amplifiers and radio cassette players.
- 4. Lightweight, compact design**

The lightweight, compact design makes it easy to use anywhere.

Cautions on Handling

Cleaning

- Use a wiping cloth and wipe lightly to remove dirt from the cabinet and operation panel.
When using chemically treated cloths, follow the precautions that have been written for them.
- Do not use benzene, thinners, or other organic solvents or insecticides on the unit since they may cause a change in quality or color.
- **Moving the unit**
To prevent short-circuits or damaged wires in the connection cables, always unplug the power supply cord and disconnect the connection cables between all other audio components when moving the unit.

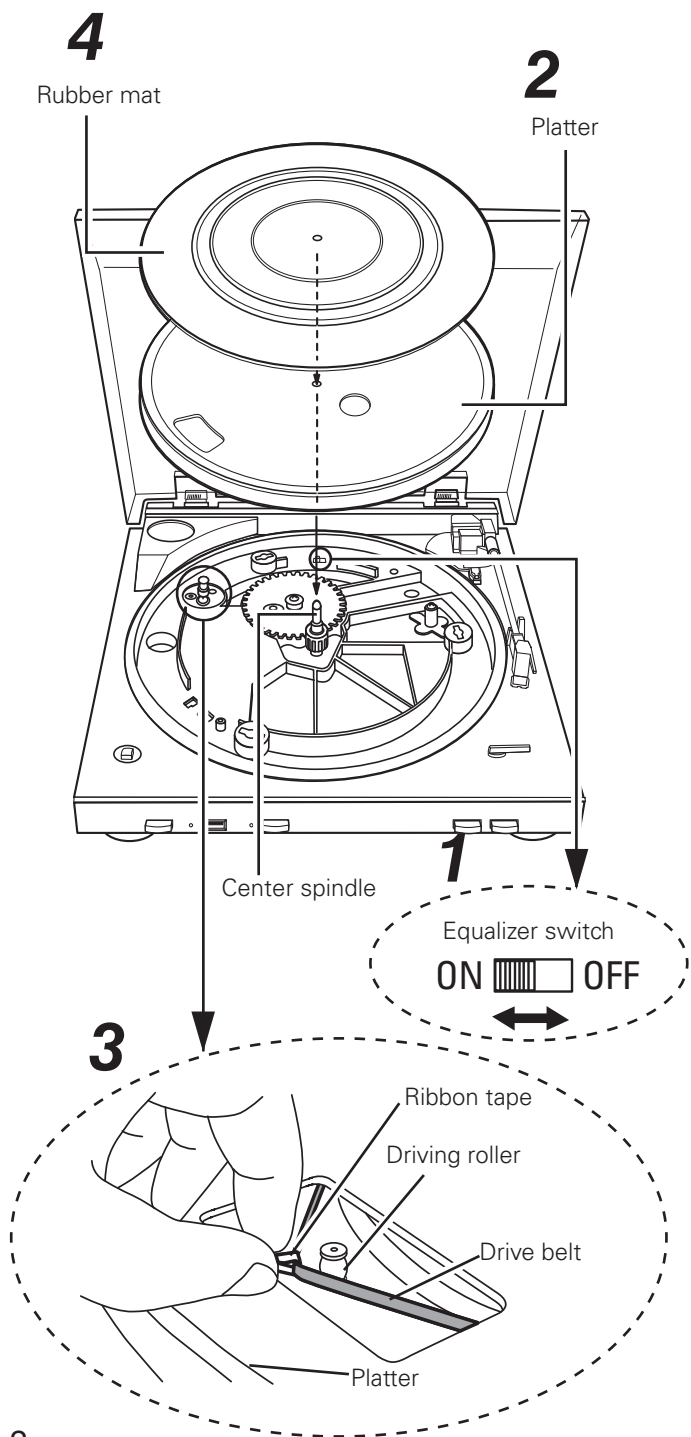

Assembly

Before assembly, remove all packaging material except for the plastic tie securing the tone arm and open the dust cover. Leave the plastic tie securing the tone arm until assembly is complete.

1 Set the equalizer switch to the appropriate position for the type of input terminal on the device connected to the DP-200USB.

ON :When connecting to an AUX input terminal or an input terminal other than "PHONO" (default setting at time of purchase).

OFF :When connecting to a PHONO input terminal.

2 Mount the platter on the center spindle.

Turn the platter so that the drive roller is visible through the opening in the platter.

3 Take hold of the ribbon tape attached to the drive belt on the underside of the platter and hook the drive belt onto the driving roller.

- Remove the ribbon tape after hooking the belt onto the roller.
- Turn the platter by hand until the drive belt is positioned at the center of the driving roller.

4 Place the rubber mat on the platter.

NOTE

If the equalizer switch is not set correctly, the sound will be extremely weak or distorted.

Changing the Stylus

The stylus supplied with the DP-200USB has a life of approximately 400 hours. Be sure to replace it in good time to avoid damaging your precious records.

Before replacing the stylus

Unplug the player at the wall socket.

Removing the Replaceable Stylus

Hold the cartridge steady with one hand, grasp the stylus with the other hand, push down in the direction of arrow ① and then gently pull the stylus off in the direction of arrow ②.

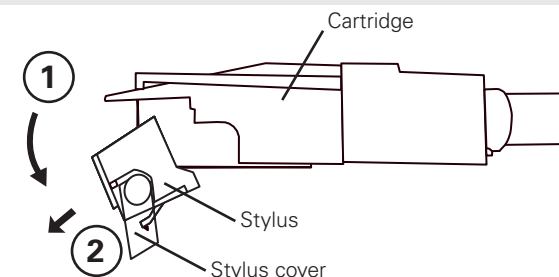

Mounting the Replaceable Stylus

Hold the cartridge steady with one hand, grasp the stylus with the other hand, point the catch on the stylus in the direction of arrow ① and insert it fully into the long opening in the cartridge, then push up in the direction of arrow ② until it clicks.

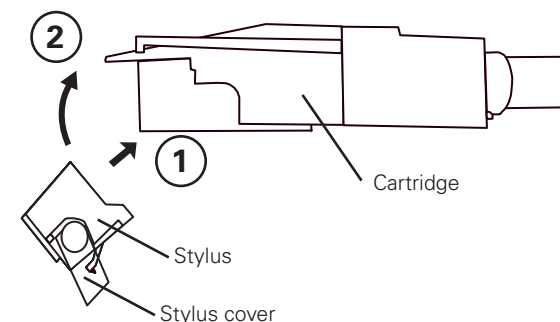

Cleaning the tip of the stylus

The tip of the stylus is extremely delicate and should be handled with great care. Use a soft brush to gently remove any dust from the tip.

Part Names and Functions

<Front>

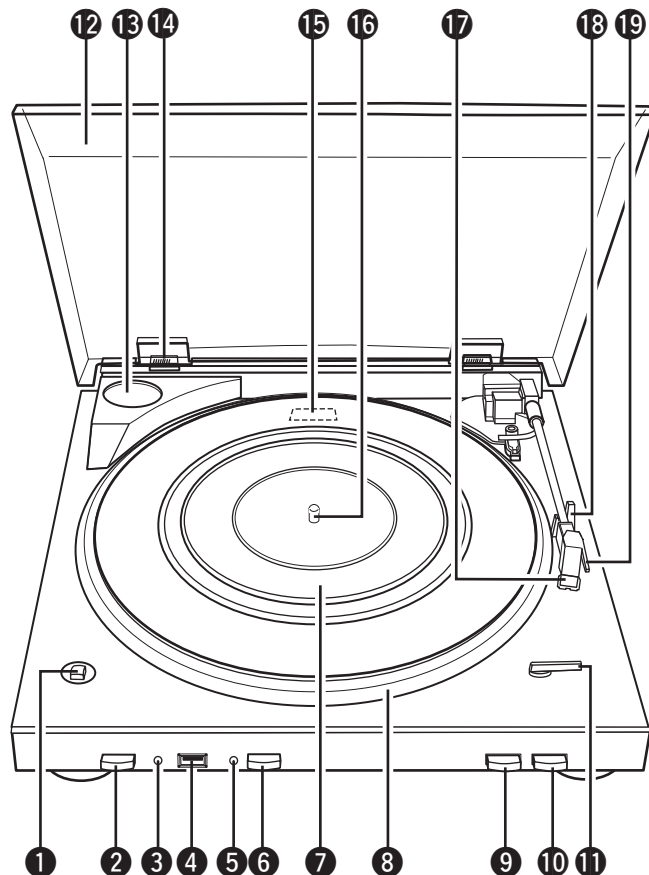

<Rear>

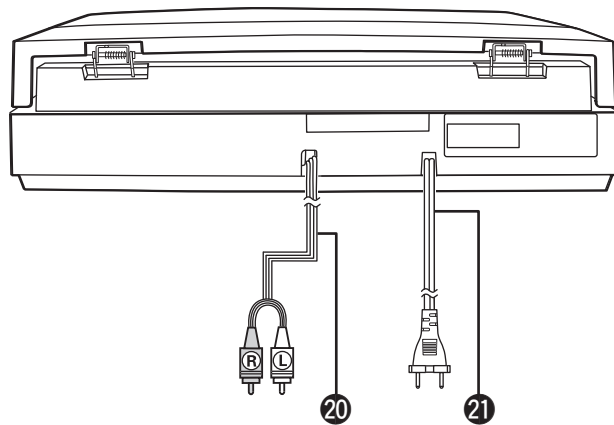

For buttons not explained here, see the page indicated in parentheses ().

- ① Speed button (SPEED 33/45)..... (5)
- ② Power operation button (POWER ON/OFF)..... (5)
- ③ USB indicator..... (8)
- ④ USB port..... (8)
- ⑤ Recording indicator..... (8)
- ⑥ REC ON/OFF button..... (8)
- ⑦ Rubber mat..... (2)
- ⑧ Platter..... (2)
- ⑨ START button..... (5)
- ⑩ STOP button..... (5)
- ⑪ Record size lever (SIZE 30/17)..... (5)
- ⑫ Dust cover..... (5)
- ⑬ EP adapter holder..... (5)
Keep your EP adapter here when not in use.
- ⑭ Dust cover hinge
- ⑮ Equalizer amplifier switch..... (2)
- ⑯ Spindle..... (2)
- ⑰ Cartridge (record stylus)..... (5)
- ⑱ Tone arm rest
- ⑲ Finger lift..... (5)
- ⑳ Audio cable (Cord length: Approx. 1 m)..... (4)
- ㉑ Power cord (Cord length: Approx. 1.8 m)..... (4)

Connections

NOTE

- Do not plug in the power cord until all connections have been completed.
- When making connections, also refer to the operating instructions of the other components.
- Be sure to connect the left and right channels properly (left with left, right with right).
- Do not bundle power cords together with connection cables. Doing so can result in humming or noise.

Connections

NOTE

Set the equalizer switch to the correct setting for the type of input terminal on the device to which the DP-200USB is being connected.

For details, refer to "Assembly" (page 2).

❑ When connecting to a PHONO input terminal

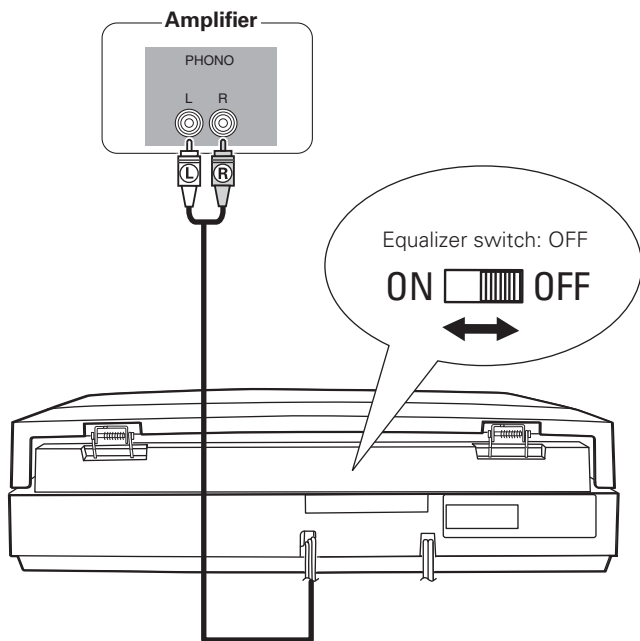

❑ When connecting to an AUX input terminal or an input terminal other than "PHONO"

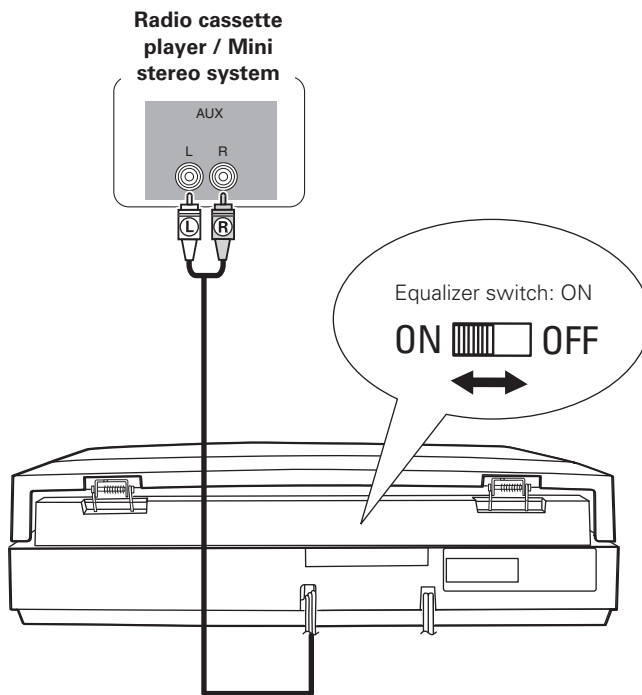

Connecting the Power Cord

Wait until all connections have been completed before connecting the power cord.

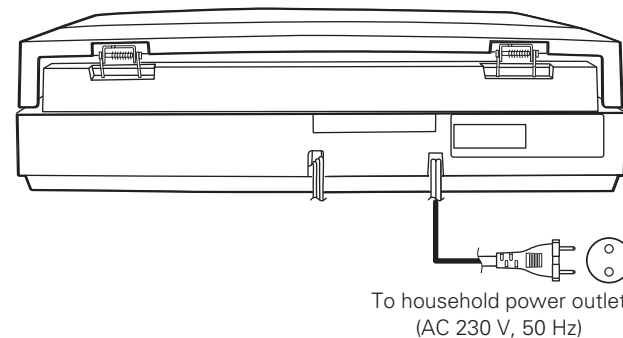

NOTE

Insert the AC plugs securely. Incomplete connections could cause noise.

Playback

The DP-200USB can play analog records. It also enables you to record your records onto a USB flash drive. For details on how to record to a USB flash drive, see "Recording and Editing" (page 6).

NOTE

The DP-200USB cannot play music recorded on a USB flash drive connected to the player.

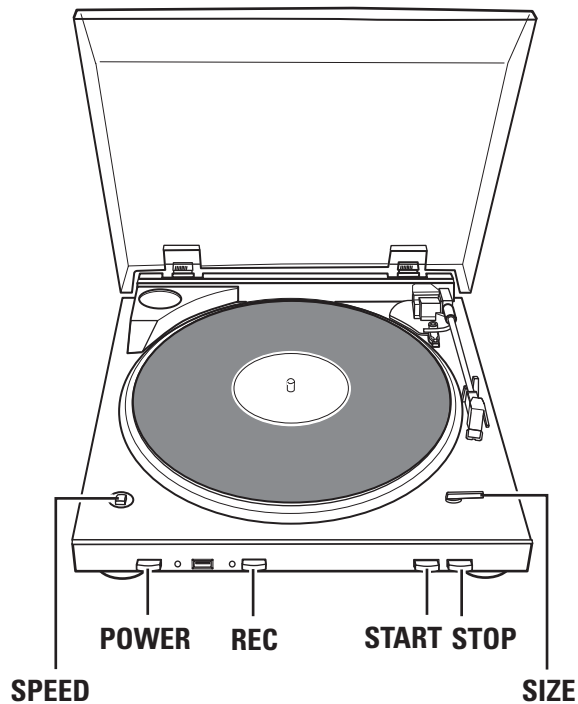

Preparations

Preparing to Play a Record

1 Press **POWER** (ON).

※ To turn power off, press **POWER** again.

2 Open the dust cover and place an analog record on the rubber mat.

※ Use the EP adapter when playing an EP record.

3 Set the record's playing speed using **SPEED**.

[Settable Items]  **33** : 33-1/3 rpm
 **45** : 45 rpm

4 Set the record's size using **SIZE**.

[Settable Items] **30** : 30 cm
17 : 17 cm

5 Raise the stylus cover.

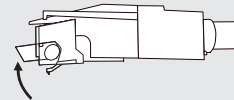

Playing an Analog Record

Auto Start

Press **START**.

The record starts playing automatically.

※ When the record is finished, the tone arm returns to its original position and the turntable stops automatically. (Auto return function)

※ To stop playing a record, turn the **POWER** "  OFF".

Manual Start

Using the finger lift, move the tone arm to the position at which you want to start playing and lower it carefully.

※ When the record is finished, the tone arm returns to its original position and the turntable stops automatically. (Auto return function)

NOTE

- Be careful not to scratch the record when moving the tone arm.
- Do not touch the tone arm or turntable or turn off the power while a record is playing. Doing so can disrupt the sound or damage the record.
- The auto start function cannot be used for 25 cm records. Records of this size should be started manually.
- The auto return function is activated when the tone arm reaches a specific point near the center of the record. In the case of a non-standard record with grooves extending beyond this point, the auto return function may be activated before the record has stopped playing.

Stopping a Record During Playback

Press **STOP**.

Playback stops and the tone arm returns to its original position.

Recording and Editing

Recording an Analog Record and Editing the Recording

Recording

You will need the following items:

DP-200USB

USB flash drive

Analog record

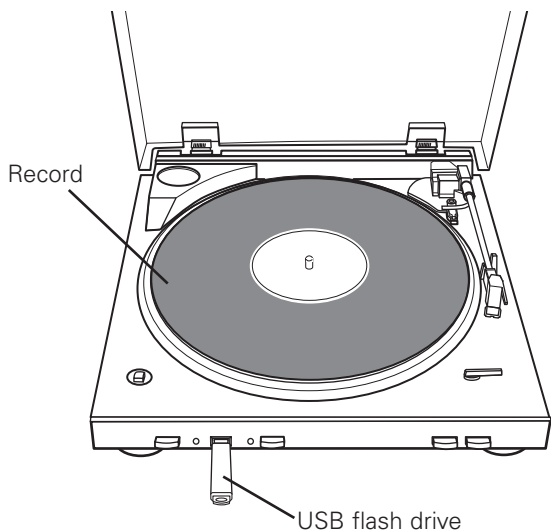

- Create a new file for each recording operation.
- Create MP3 music files.
- With a 1 GB USB flash drive, you can store up to approximately 30 LP analog records.

Editing

You will need the following items:

Trans Music Manager (CD-ROM)

A personal computer connected to the Internet

A USB flash drive containing your recording

Split files

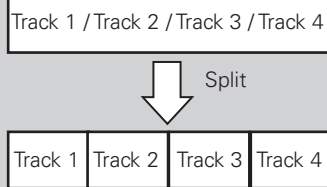

Add information such as the title of the track or album or the name of the artist

There are two ways to do this.

- ① **Download from "MusicID*"**.
*A system for retrieving information on music tracks from Gracenote's CD database.
- ② **Enter the information using your personal computer's keyboard.**

Delete files

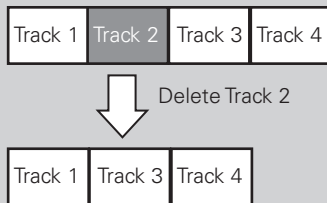

Edited files can be saved on your personal computer. (You can also save them onto a USB flash drive.)

Playback

You will need the following items:

USB flash drive containing edited (or recorded) files

Audio device with USB input

or

Personal computer

Playing on an audio device

Play on an audio device with a USB port. (When the file has been edited on a personal computer, transfer the data to a USB flash drive.)

Playing on a personal computer

Play using the Trans Music Manager software or the audio player software installed on your personal computer.

Cautions to Observe When Recording or Editing

Cautions When Recording

- Do not remove the USB flash drive during recording. Doing so will prevent recording from taking place. Make sure that recording has finished before removing the USB flash drive.
- If the USB flash drive becomes full during recording, the recording operation will stop and the USB indicator will turn off.
- Although the tone arm will return to its original position at the end of the record, the USB flash drive does not stop recording automatically. To stop recording, press the **REC** button.
- The recording level of the USB flash drive is fixed. To adjust the volume when playing the music, use the volume controls on the audio device being used.
- If the **REC** button is turned on and then off again in less than one second, no recording will take place.
- If you record both sides of an analog record without stopping, the recording will contain a long period of silence while changing from side A to side B. To prevent this, you should stop recording after side A and start again to record side B.

Notes on Downloading Track Information

You can use the “Trans Music Manager” software included with the DP-200USB to download information on the recorded track (the title of the track or album or the name of the artist, etc.) from the Gracenote website.

- Downloading with Trans Music Manager.
 - ① Read out the opening few seconds of the recorded track’s audio waveform.
 - ② Search for a matching waveform in Gracenote®’s CD database.
 - If a match is found, the title of the track is displayed in the download list.
 - ③ Download the information.
- Track information cannot be downloaded in the following cases. In such cases, you should enter the information yourself.
 - When the recorded record has not been released as a CD.
 - When the recording contains excessive noise due to use of a worn stylus or a similar problem with recording quality.
 - When the sound quality of the CD version of the record has been enhanced by remastering, etc.

About USB Flash drive

- Only use a USB flash drive. Do not connect any other USB device.
- When a USB flash drive is connected to DP-200USB, DENON accepts no liability in the event of the USB flash drive’s data loss or damage. Be sure to back up important data.
- The USB flash drive does not operate via a USB hub.
- Operation and power supply are not guaranteed for all USB flash drives.
- The main unit’s USB port cannot be connected to a PC using a USB cable.
- Insert the USB flash drive straight and fully into the USB port. Avoid inserting at an angle as this can cause damage.
- You cannot use USB flash drives that are copyright protected.
- You cannot record on an external hard disk drive.
- You cannot record via a USB cable (including extension cable).

About Compatible OS and Personal Computers

- The following OS are compatible. Windows 2000 / Windows XP / Windows Vista (The display screen may differ in part depending on the personal computer.)
- You cannot output information to a personal computer by connecting the main unit to a personal computer.
- Operations such as system suspend, sleep (standby mode), hibernation, etc., cannot be guaranteed for all PCs.

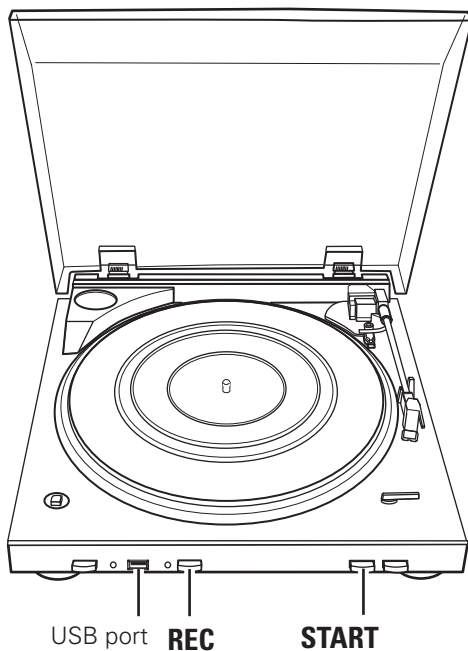

Recording

Recording to a USB Flash Drive

1 Prepare the analog record you want to record for playing (☞ page 5 “Preparing to Play a Record”).

- ① Place the record on the rubber mat.
- ② Set the record's playing speed.
- ③ Set the record's size.
- ④ Turn the power on.

2 Insert a USB flash drive into the USB port.

- The USB indicator lights green.
- ※ If the USB flash drive has a write protection switch, make sure that it is in the unlocked position.

3 Press REC.

- The Recording indicator lights red (preparing to record).
 - The Recording indicator blinks red and recording starts.
- ※ The time from pressing **REC** (the recording indicator lights red) to when recording starts (the red light blinks) varies with the USB flash drive capacity and type. Check the time to start of recording beforehand.

4 Press START.

- ※ If you are starting the record manually, use the finger lift to move the tone arm to the position at which you want to start playing and lower it carefully.

NOTE

- When removing the USB flash drive, gently hold the DP-200USB with your other hand to keep it steady.
- Do not remove the USB flash drive during recording.

☐ To Stop Recording

- Press **REC**.
- The Recording indicator turns off.



The included “Trans Music Manager” can be used to delete silent sections recorded before and after a track.

- ① Create a single track from the section to be deleted.
“Manual MP3 Splitter” (☞ Brief manual (CD-ROM) page 11)
- ② Delete the track created in step ①.
“Deleting tracks” (☞ Brief manual (CD-ROM) page 28)

Editing

Shall be Enabled by Trans Music Manager for DENON

You can use Trans Music Manager to perform the following functions.

- ☐ File Splitter
 - Auto MP3 Splitter
 - Manual MP3 Splitter
- ☐ MusicID (Addition of track information)
 - Track name, Artist name, Album name, etc.
 - Access Gracenote® on the internet
 - Character Entry
- ☐ File deletion

Trans Music Manager is a trademark and registered trademark of Trans Technology, Inc.
Information concerning music identification technology is offered by Gracenote, Inc.
Gracenote® and CDDB® are registered trademarks of Gracenote.

About Gracenote MusicIDSM Music Recognition Service

“Gracenote MusicIDSM music recognition service” is a service offered by Gracenote® that is commonly known as CDDB®. The service lets you automatically obtain CD titles, artist names, track names, etc., in text format by connecting to the Gracenote® server on the Internet.

Recommended System Requirements for Using Trans Music Manager

- A personal computer running Windows 2000/Windows XP/Windows Vista
- An HDD with a minimum of 30 MB free space
- A USB 2.0 port

Installing “Trans Music Manager”

1 Insert the included CD-ROM (Trans Music Manager) in your PC.

The top menu screen is displayed.

- ※ If the top menu screen is not displayed, open the CD-ROM drive under “My Computer” and start “TMMLaunch.exe”.

2 Click on “Trans Music Manager installation”.

The InstallShield Wizard screen is displayed.

3 Operate while reading the screen explanations.

Installation starts.

4 Click on “Finish”.

Installation finishes.

Editing with Trans Music Manager

For details of the editing operation, refer to the “Simple User’s Guide” which is included on the CD-ROM supplied with the DP-200USB.

Troubleshooting

If a problem should arise, first check the following:

1. Are the connections correct?

2. Is the set being operated as described in the owner's manual?

If this unit does not operate properly, check the items listed in the table below. Should the problem persist, there may be a malfunction.

In this case, disconnect the power immediately and contact your store of purchase.

[Playing records]

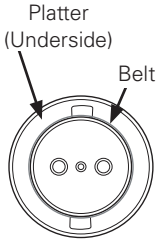
Status	Check	Page
Power does not turn on.	<ul style="list-style-type: none"> Is the DP-200USB's power cord plugged into the wall socket properly? Is the power button "ON"? 	4 5
The turntable does not turn.	<ul style="list-style-type: none"> Is the DP-200USB's power cord plugged into the wall socket properly? Is the drive belt attached properly to both the platter and the driving roller? If the drive belt has become detached, reattach it to the platter first and then hook it onto the driving roller. For details, refer to "Assembly" (page 2). 	4 2
No sound is produced	<ul style="list-style-type: none"> Is the audio cable connected properly? Has the amplifier been set correctly for use with the DP-200USB audio cable? Is the replaceable stylus mounted in the cartridge properly? 	4 4 2
The sound is scratchy, the stylus skips or the sound is distorted.	<ul style="list-style-type: none"> Is the stylus or the record dirty? Is the stylus worn or the record scratched? 	2 2
The tone arm does not move even when the START button is pressed.	<ul style="list-style-type: none"> Is the DP-200USB's power cord plugged into the wall socket properly? Is the power button "ON"? Is the tone arm secured to the armrest? 	4 5 3

[USB flash drive]

Status	Check	Page
The USB flash drive is not recognized.	<ul style="list-style-type: none"> Is the USB flash drive inserted fully into the port? Is the USB flash drive full? 	8 8
Nothing is recorded on the USB flash drive.	<ul style="list-style-type: none"> Is the USB flash drive inserted fully into the port? Is the USB flash drive full? The USB flash drive is incompatible with the personal computer. Was the USB flash drive removed during recording (without stopping recording)? 	8 8 8 8
The USB flash drive cannot be formatted.	<ul style="list-style-type: none"> You cannot format a USB flash drive with the DP-200USB. To format the flash drive, use your personal computer. 	-

[Editing]

Status	Check	Page
Files cannot be edited	<ul style="list-style-type: none"> Have you installed the CD-ROM supplied with the DP-200USB on your personal computer? Has the file been recorded on the USB flash drive properly? (Has the file of the track been created in the folder properly?) Is your personal computer connected to the Internet? (Track information cannot be downloaded if you are not connected to the internet.) 	8 - 6
Files cannot be batch split	<ul style="list-style-type: none"> Change the batch split setting menu and try the batch splitting operation again. Batch splitting of files is not possible under certain recording conditions. In such cases, the files can be split manually. 	8 8
Track information does not download	<ul style="list-style-type: none"> Is your personal computer connected to the Internet? Track information cannot be downloaded in the following cases. <ul style="list-style-type: none"> When the record concerned has not been released as a CD (it is not in the CD database). When the sound has not been recorded properly due to a worn stylus. When the sound quality of the CD version of the record concerned has been enhanced by remastering, etc. 	6 7
Track information is acquired only for some of the files of a recorded album	<ul style="list-style-type: none"> Select "Identify tracks as albums" when searching MusicID. Even if the search finds only one matching track in the album, you can obtain the track information from the album list manually. 	8 8

Specifications

Turntable

Drive system:	Belt drive
Motor:	DC servo motor
Speed:	33-1/3, 45 rpm
Wow & flutter:	0.15 % WRMS
Tone arm:	Dynamic balanced type
Effective arm length:	195 mm
Cartridge:	MM type
Output voltage:	Equalizer OFF: 2.5 mV Equalizer ON : 150 mV
Optimal stylus pressure:	3.5 g
Replaceable stylus number:	DSN-84
USB port :	USB recording, compatible with USB A and USB 1.1

General

Power supply:	AC 230 V, 50 Hz
Power consumption:	12 W
Maximum external dimensions:	With dust cover closed: 360 (W) × 98 (H) × 358 (D) mm With dust cover open: 360 (W) × 415 (H) × 363 (D) mm
Weight:	3.2 kg

* For purposes of improvement, specifications and design are subject to change without notice.

DENON

www.denon.com

D&M Holdings Inc.
Printed in China 5411 10165 107D